

# **INCENTIVO**

**CLASES CON  
ALICIA**

## **CULTO FAMILIAR**

**La idea que les compartimos, es tener una figuras cada semana, donde alla 7 cosas, figuras o objetos que se repitan, estas 7 cosas representarán los días de la semana. Los niños podrán pintar todo, pero de los 7 cosas, solo 1 cada día que estudia su lección.**

**Papis, no permitamos que pinte, si no se hizo el Culto.**

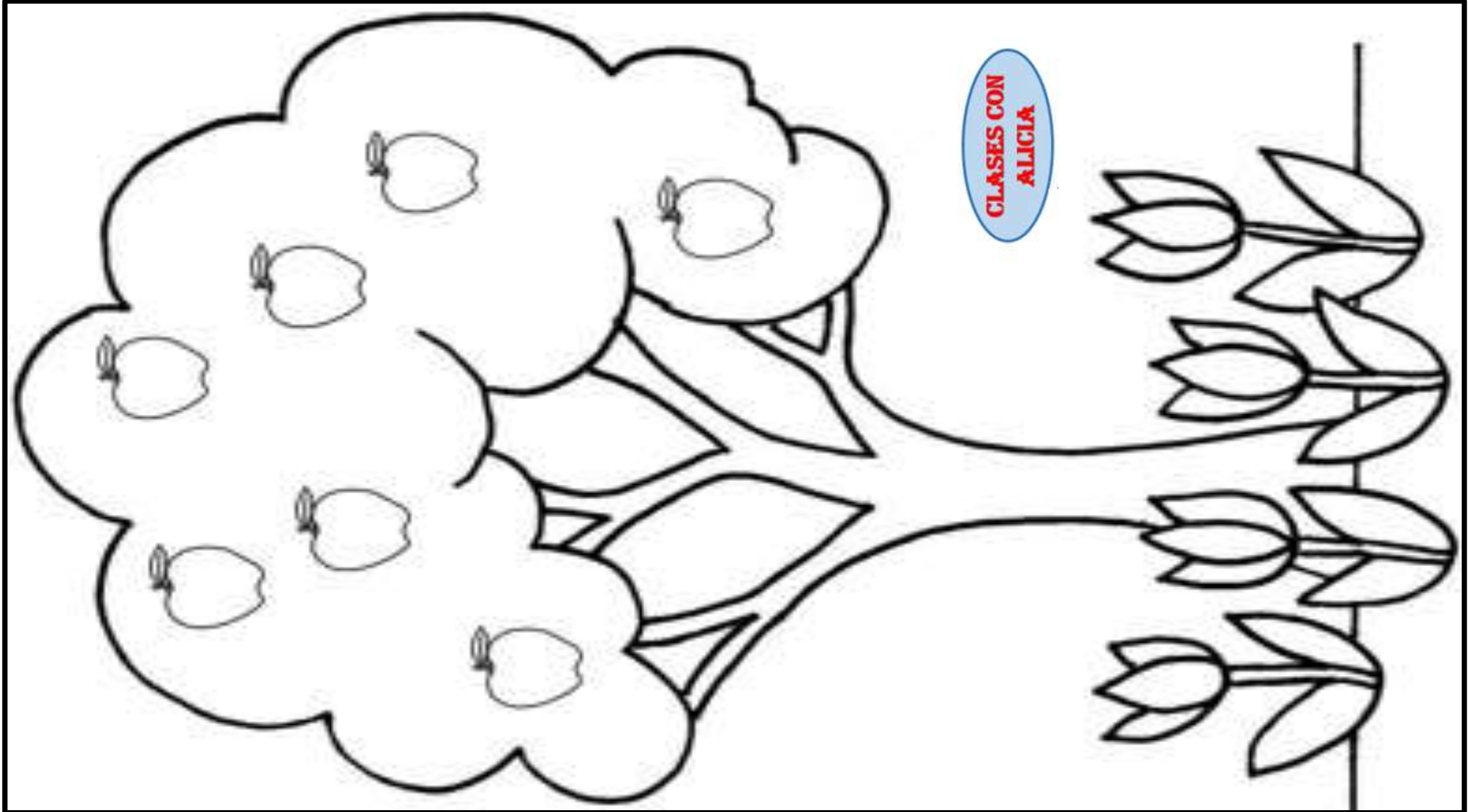

**CLASES CON  
ALICIA**

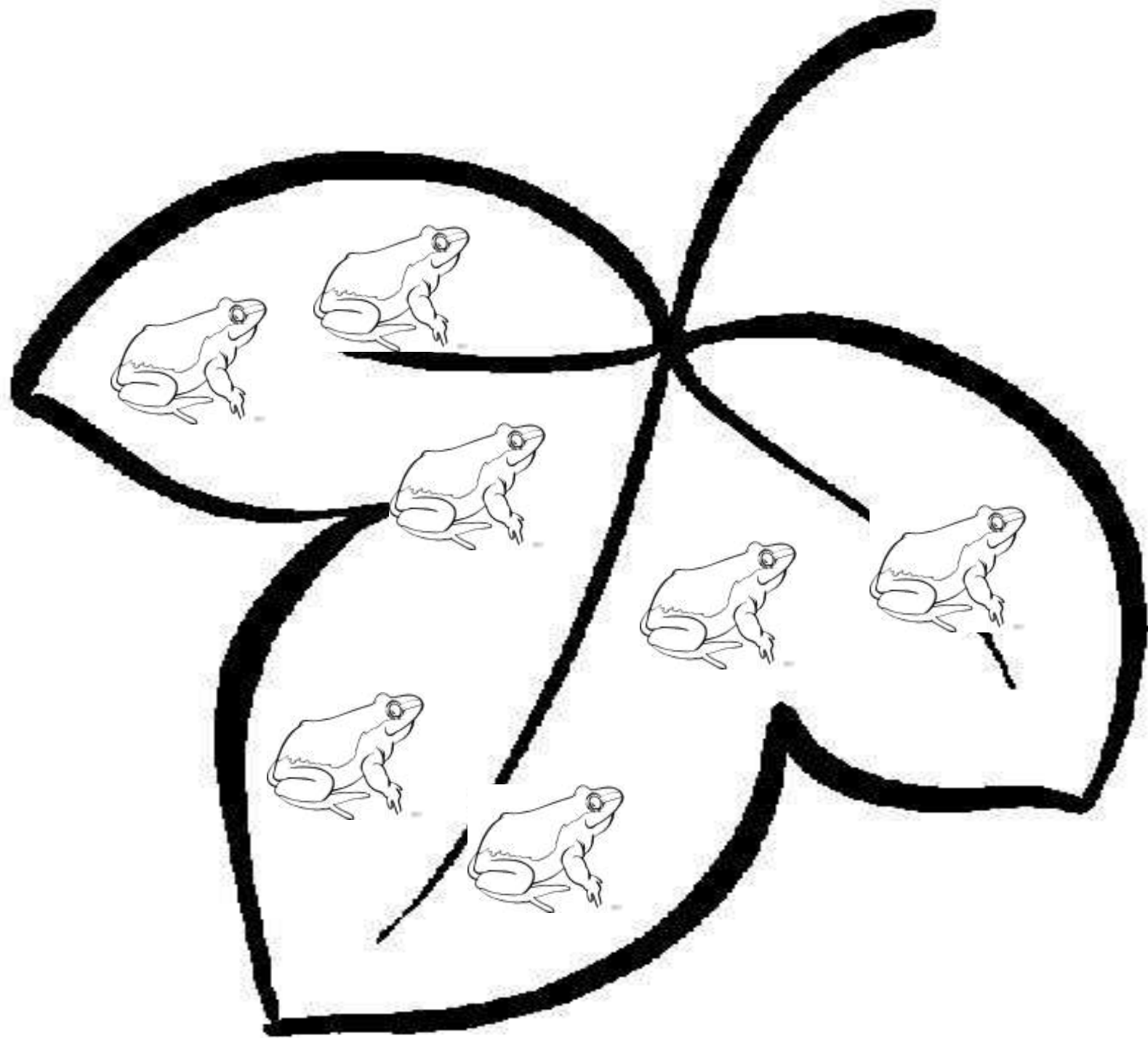

**CLASES CON  
ALICIA**

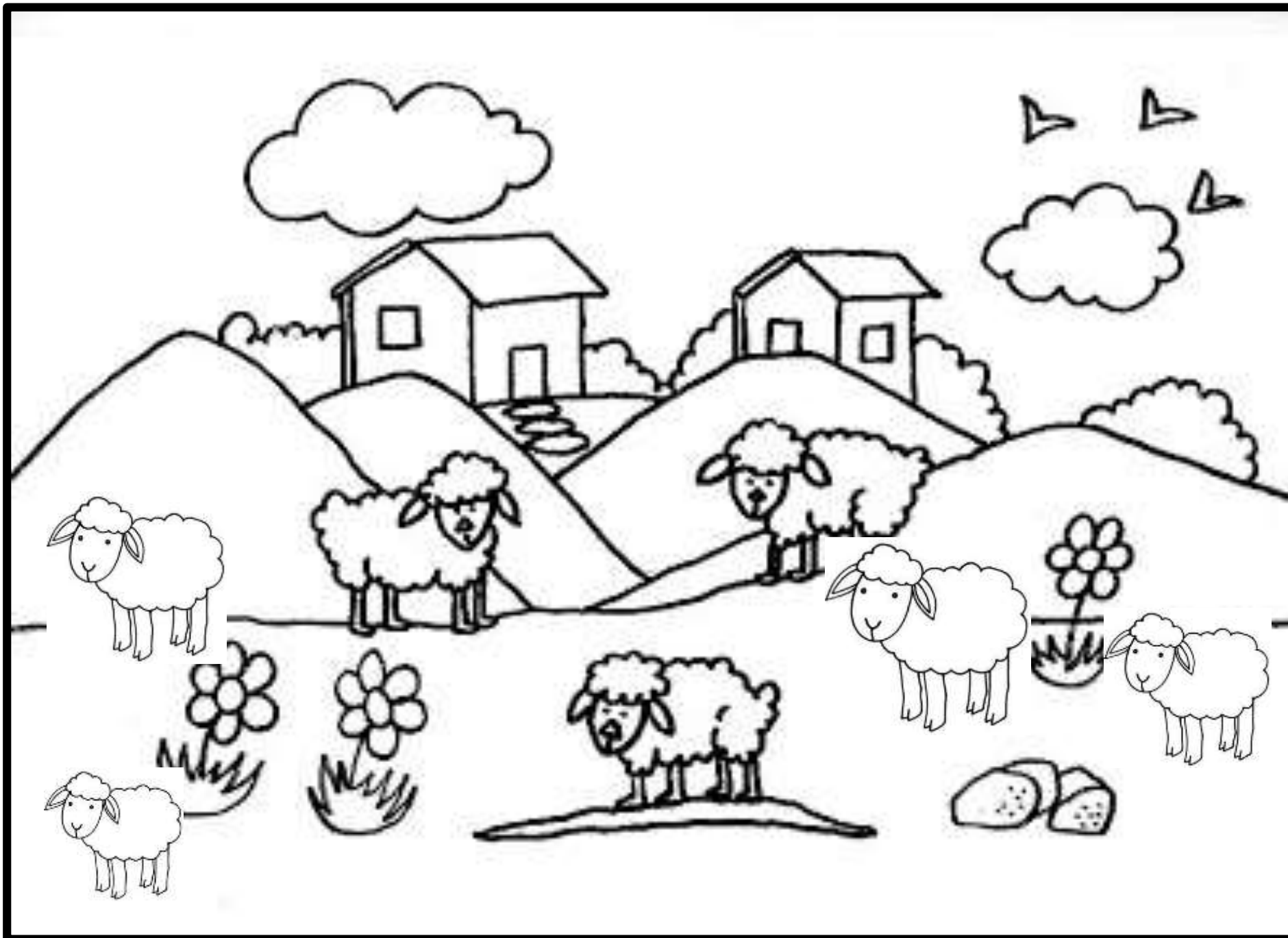

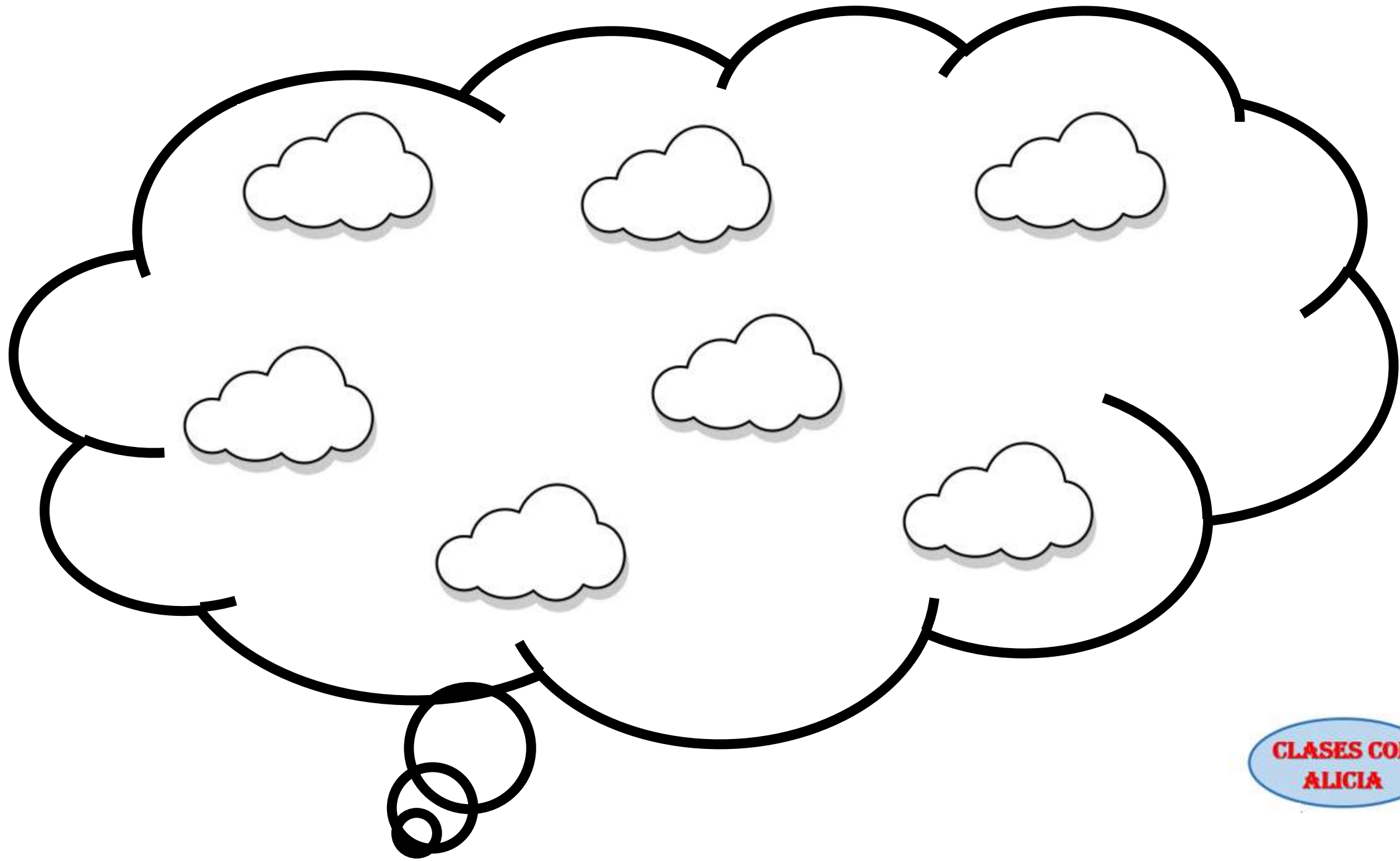



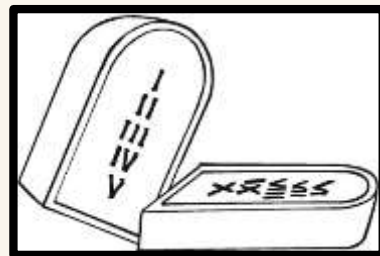
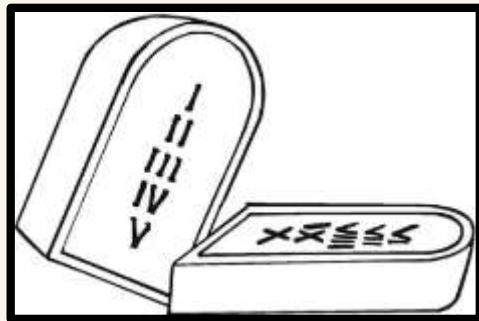
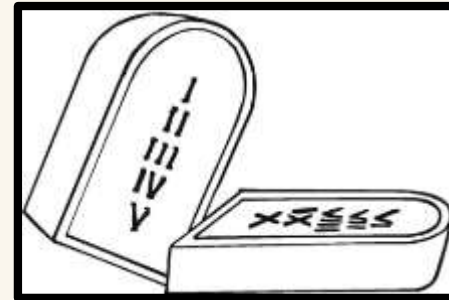
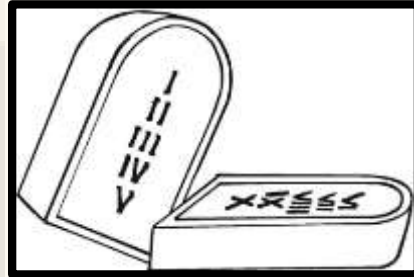
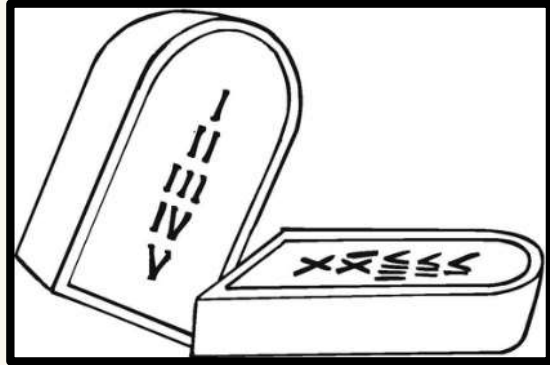
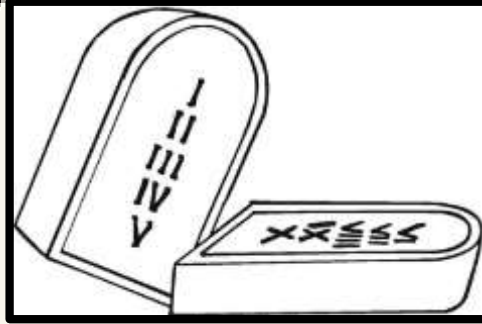
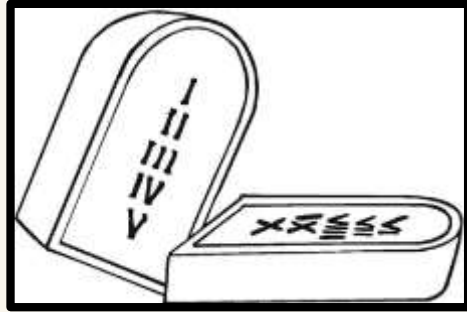



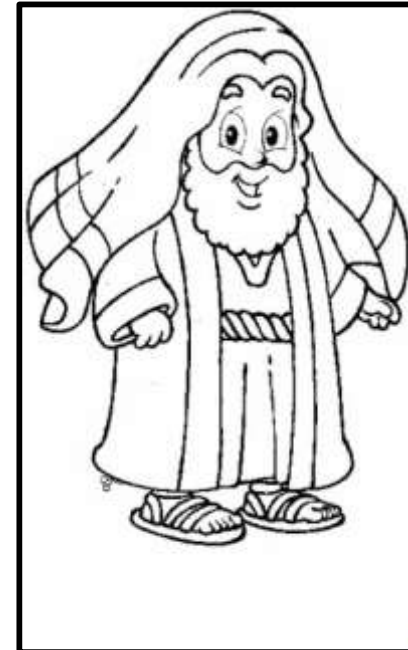
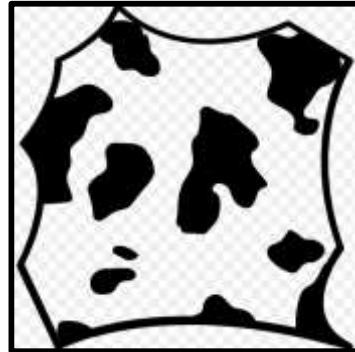
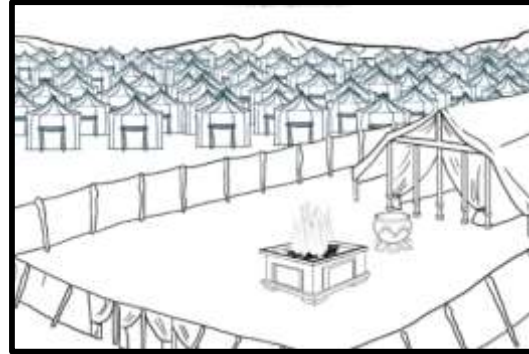
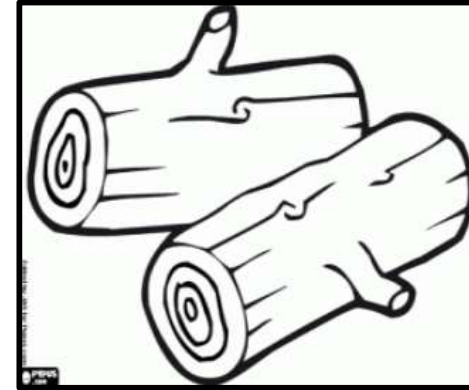
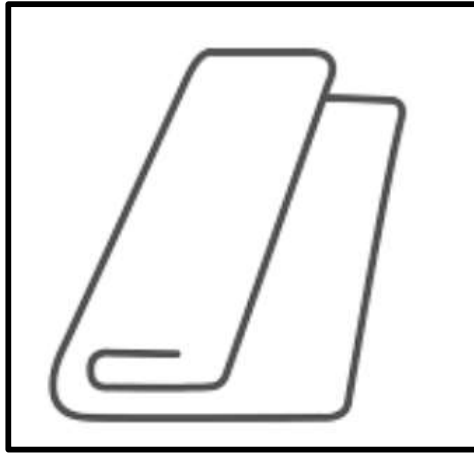
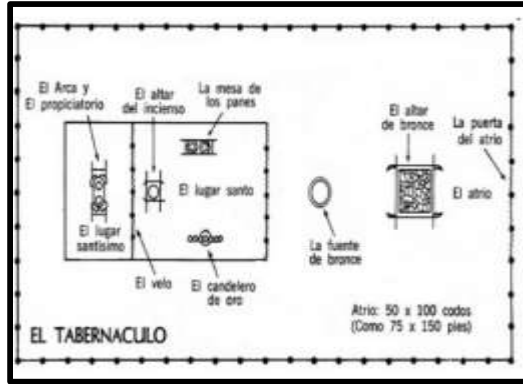



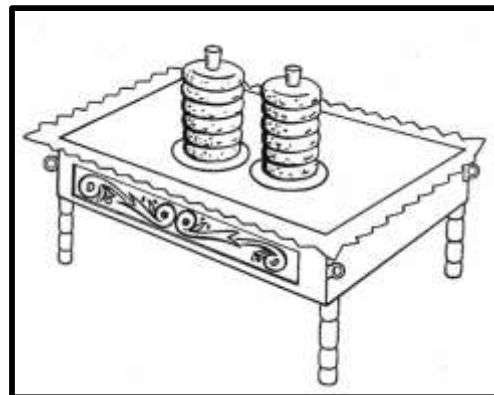
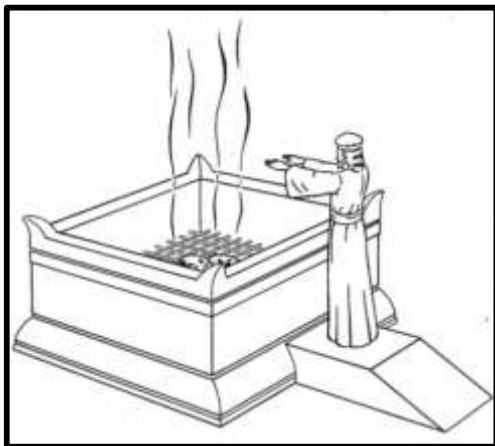
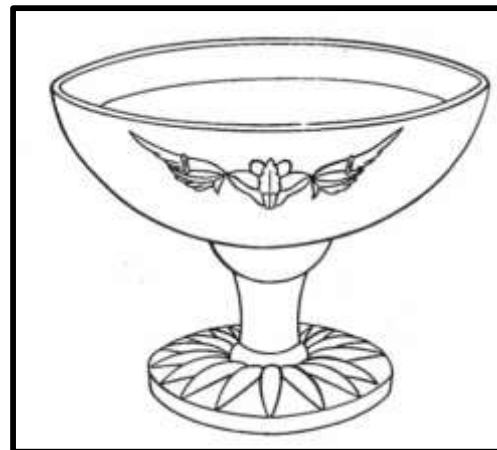
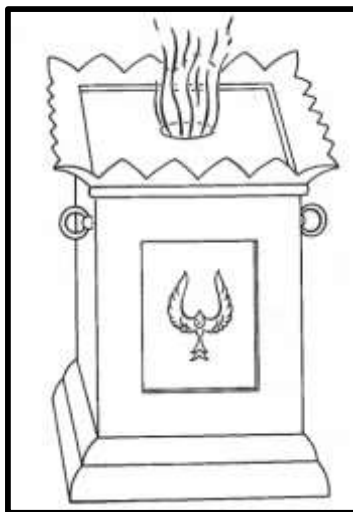

**CLASES CON  
ALICIA**

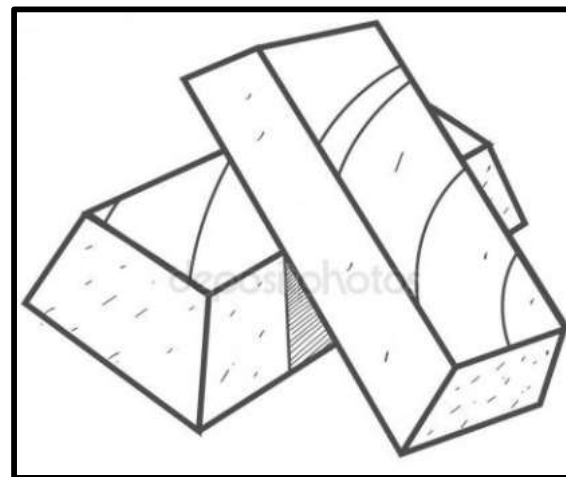
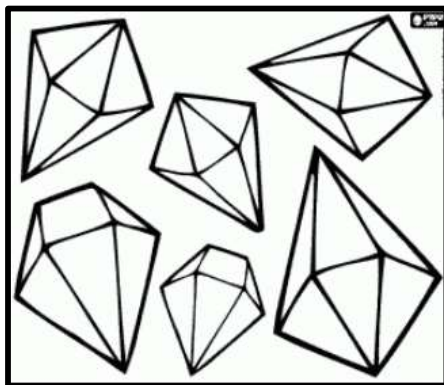
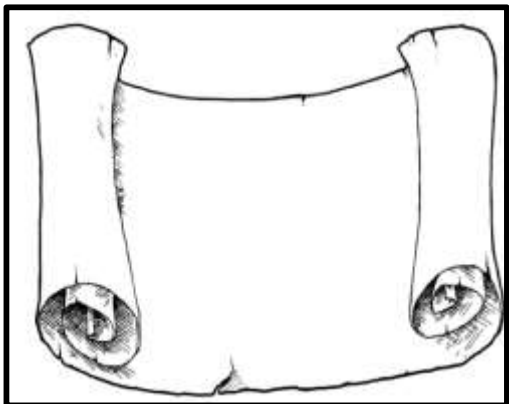
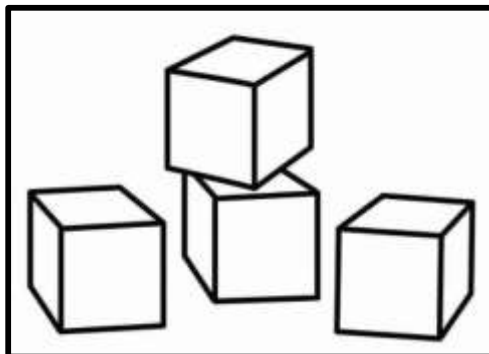
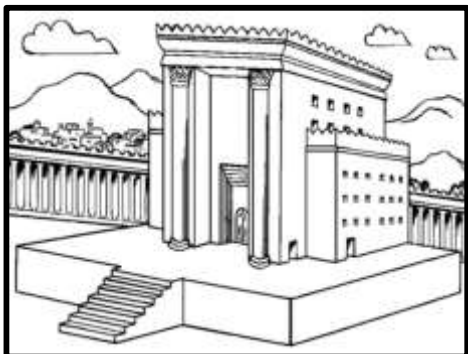

**CLASES CON  
ALICIA**